

FEATURES:

- ★ 550 mA Adjustable Constant Current Driver
- ★ Up to 96% Efficiency
- ★ Up to 1MHz switching frequency
- ★ Integrated Power Switch
- ★ Wide input voltage range of 6 to 30V
- ★ Single pin on/off and brightness control using DC voltage or PWM
- ★ Integrated Thermal Protection
- ★ Integrated Under Voltage Lockout
- ★ Integrated Open/Short protection
- ★ Integrated Soft Start Function
- ★ Only 3 external components required.
- ★ Pin compatible with competitor products - reduces redesign cost.
- ★ Available in TSOT23-5 and SOIC-8EP. (Inquire about other package options.)

APPLICATIONS:

The TXLE10 series of high efficiency and safety engineered products are ideal for most applications:

Illuminated Signage
Automotive Lighting
MR16 and Halogen replacement LED Lighting
High Power LED Lighting
Industrial Lighting
LCD TV Backlighting
Switch Mode Power Supply

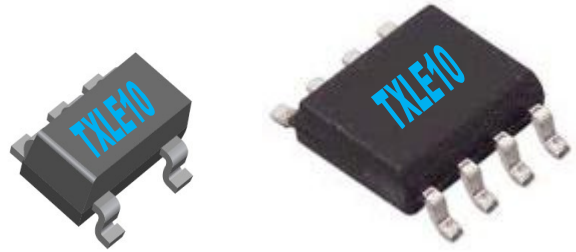

TXLE10-3306-TS5

TXLE10-3306-EP8

PRODUCT OVERVIEW:

The TXLE10 series products are optimized constant current step-down DC/DC converters, adjustable for a wide range of voltage and current applications. They deliver controlled output current up to 550 mAmps across a 6V to 30V input range. These products are manufactured in an advanced BiCMOS process to create a precision current reference and feedback loop, achieving less than 0.5% line regulation. Dimming control is provided through DC level control or pulse width modulation. Soft-start circuitry requiring no external components is implemented to limit in-rush current. This integrated soft-start can be further enhanced for more demanding applications with the use of an external capacitor. To enhance safety in system applications, integrated under-voltage lockout, short-circuit, and open-circuit protection are incorporated. Robust thermal control is included to minimize system overheating to improve load (LED) and driver lifetime and reliability. This fully integrated thermal protection mode controls junction temperature to 155C (typ). The TXLE10 products are offered in a wide array of packages to maximize system design flexibility. TXLE10 products are ideal for LED lighting, DC/DC converter module and high efficiency line regulation applications.

ORDERABLE PRODUCT PART NUMBERS TABLE:

Product Number	Package Description
TXLE10-3306-TS5	5 Pin TSOT23
TXLE10-3306-EP8	8 Pin Thermally Enhanced SOIC-EP

PINOUTS:

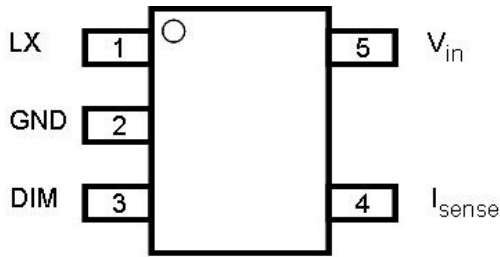

TSOT23
5 pin
Package

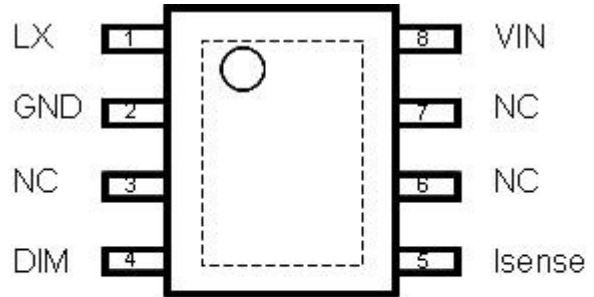

SOIC-EP
8 pin
Package

TYPICAL APPLICATION CIRCUITS:

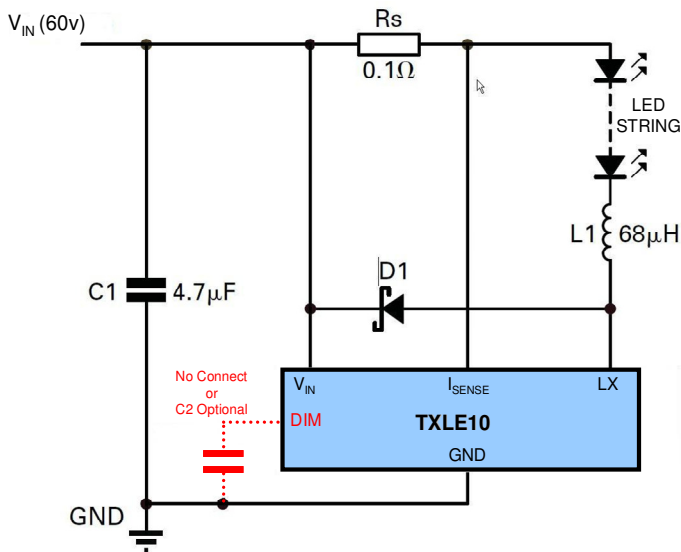

Optional DIM Pin Connected

4 External Components

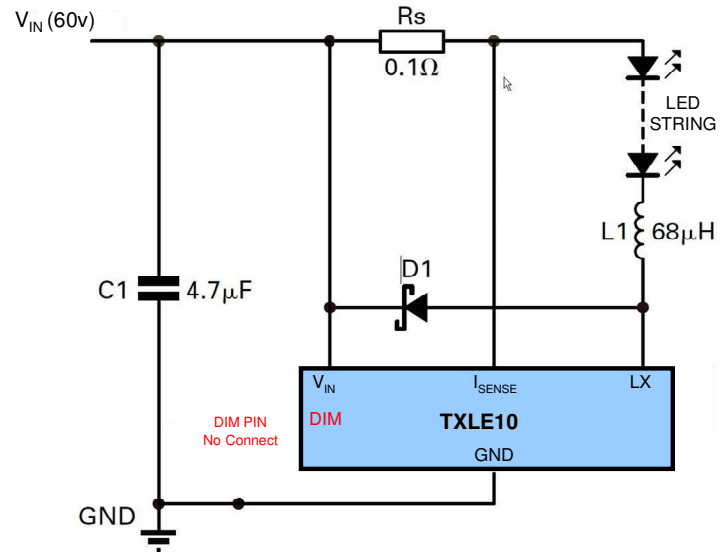

Soft Start Function Enabled

DIM Pin no-connect

3 External Components

January 23, 2013

Page 2 of 17

BLOCK DIAGRAM:

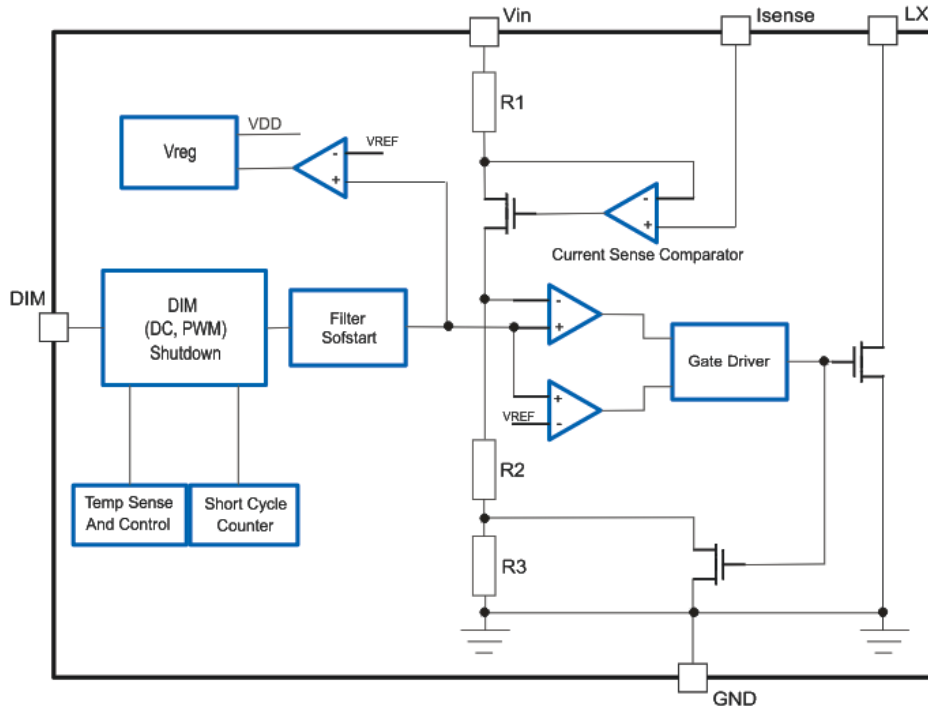

Figure 1: Block Diagram

PIN DESCRIPTION:

Name	Description
LX	Drain of NDMOS Switch
GND	Ground
DIM	Multi-function ON/OFF and brightness control pin. <ul style="list-style-type: none"> • Leave floating for normal operation. Here, $V_{DIM}=V_{REF}=1.25V$ and $I_{OUT}=0.1/R_S$ • Drive with DC voltage between 0.3V and 2.5V to modify output current over the range 25% to 200% I_{OUTnom}. In this case, $I_{OUTnom} = (V_{DIM}/1.25)*0.1/R_S$. • Connect a capacitor from this pin to ground to increase soft-start time at a rate of 0.2mS/nF. Note that the built-in soft-start time is a function of the output switching frequency, and turns on the output current linearly with time over 1024 output cycles. • To turn off output current, drive below 0.2V. • When driven above 3V, the built-in soft-start feature is disabled.
I _{SENSE}	Connect resistor R_S from this pin to V_{IN} to define nominal average output current $I_{OUTnom} = (V_{DIM}/1.25)*0.1/R_S$ where $R_{Smin}=0.083\Omega$ for open circuit DIM pin.
V _{IN}	Input voltage
NC	Can be left floating or connected to ground for improved thermal conductivity.

ABSOLUTE MAXIMUM RATINGS:

Symbol	Parameter	Rating	Unit
V _{IN}	Input Voltage	-0.3 to +30 (33V for 0.5sec)	V
V _{SENSE}	I _{SENSE} Voltage	0.3 to -0.5 (with respect to V _{in})	V
V _{LX}	LX Output Voltage	-0.3 to +30 (33V for 0.5sec)	V
V _{DIM}	DIM Pin Input Voltage	-0.3 to 6V	V
I _{LX}	LX Output Current	550	mA
P _{TOT}	Power Dissipation	1	W
T _{ST}	Storage Temperature	-55 to 155	C
T _{JMAX}	Junction Temperature	155	C

These are stress ratings only. Operation above absolute maximum rating may cause device failure. Operation at the absolute maximum ratings for extended periods may reduce device reliability.

ESD Protection Limits:

	Test Method	Rating	Unit
Human Body Model	AEC-Q100-002 Rev-D	700	V
Charged Device Model	AEC-Q100-011 Rev-B	1500	V

Semiconductor devices are ESD sensitive. Suitable ESD precautions should be taken when handling and transporting these devices.

PERFORMANCE CHARACTERISTICS:

Symbol	Description	Condition	Min	Typ	Max	Unit
LineReg	Line regulation			0.5		%
LoadReg	Load regulation			0.1		%
Eff	Efficiency		85		96	%

ELECTRICAL CHARACTERISTICS:

Test conditions: $V_{IN}=24V$, $T_A=25^{\circ}C$ unless otherwise stated¹

Symbol	Description	Condition	Min	Typ	Max	Unit
V _{IN}	Supply voltage (V _{in})		6	24	30	V
V _{SD}	Under Voltage Lockout threshold		4.25	4.5	4.8	V
V _{SU}	Under Voltage Lockout recovery		4.5	4.75	5.05	V
I _{LxOut}	LX Output Current	DIM pin floating R _S =0.083Ω			550	mA
I _{InOFF}	Supply current (off state)	V _{in} =30V, DIM=0V		90	100	μA
I _{InON}	Supply current (on state)	V _{in} =30V, DIM pin floating			1.2	mA
V _{SENSE}	V _{SENSE} threshold with respect to V _{IN}	V _{DIM} =1.25V	119	125	131	mV
V _{SENSEHYS}	Vsense hysteresis			±10		%
I _{SENSE}	Vsense input current			2		μA
V _{REF}	VDIM voltage (when floating)			1.25		V
ΔV _{REF} /ΔT	Temperature coefficient of V _{REF}			50		ppm/°C
V _{DIM}	DIM range for brightness control		0.3	1.25	2.5	V
V _{DIMOFF}	DIM voltage to turn device OFF		.15	.2	.225	V
R _{DIM}	Resistance between DIM pad and V _{ref}			40		KΩ
I _{Lx(leak)}	LX leakage current				5	μA
D _{PWM(LF)}	Duty cycle range of PWM signal applied to DIM pin for low frequency PWM dimming	PWM frequency < 1KHz PWM amplitude = 0V to 1.25V	0.001		1	
	Brightness control range				1000:1	
DC _{DIM}	DC Brightness control range	Ratio of max to min brightness where V _{ref} = 1.25/0.3		5:1		
R _{DSON}	Switch on resistance	27°C, 550mA	200	500	800	mΩ
t _{SS}	Soft-start time (For detailed description, see Device and Application Description)	DIM pin floating Time for output current to reach 90% of target after voltage on DIM pin has risen above 0.3V	3		7.6	mS
f _{LXmax}	Recommended maximum operating frequency				500	kHz
t _{ONmin}	Minimum switch 'ON' time			100		nS
t _{OFFmin}	Minimum switch 'OFF' time			100		nS
t _{PWmin}	Recommended minimum switch pulse width			500		nS
D _{LX}	Recommended duty cycle range of output switch at f _{LXmax}		0.3		0.7	
T _{SD}	Thermal shutdown threshold		+145	+155	+165	°C
T _{SD-HYS}	Thermal shut down hysteresis			20		°C
Top	Operating Temp (Ambient)		-40		+125	°C

DEVICE AND APPLICATION DESCRIPTION:

TXLE10 is a switching DC to DC current converter with a low series resistance integrated switch aimed at driving an LED network in a continuous-mode buck configuration as shown in the application diagrams on Page 2.

Output current is controlled through the appropriate selection of R_{sense} .

Frequency of operation, duty-cycle and overall system efficiency are dependent on values and characteristics of the external discrete components shown in the application circuit – the inductor L1 and the Schottky diode D1. The input filter capacitor stabilizes the circuit and filters transients on the incoming DC supply.

The continuous-mode buck converter is a self-oscillating circuit comprised of the inductor L1, the LED string being driven, the feedback Schottky diode D1 and sense resistor R_{sense} and the TXLE10's integrated switch.

A simplified description of the circuit operation follows (for purpose of this description, DIM is floating).

Assume power is applied to VIN, and the switch is initially OFF. No current flows through R_{sense} , thus no voltage is developed across it. The I_{sense} comparator compares the voltage across R_{sense} to the internally generated threshold and causes the switch to turn ON. This causes current to flow through the inductor L1, energizing it, and through the LED string and through R_{sense} . A voltage develops across R_{sense} that is proportional to the current through the LEDs. When this voltage reaches the internal reference voltage, I_{sense} comparator detects this condition causing the switch to turn OFF. The inductor continues to supply current from the stored magnetic field, causing the potential at the anode of the Schottky diode to rise until the diode is forward biased, and then current flows back to the supply. The voltage across R_{sense} begins to rise as the current sourced by the inductor falls. When the rising voltage across R_{sense} reaches crosses the internal reference voltage, the I_{sense} comparator causes the switch to turn ON. This cycle repeats with the current through the LEDs oscillating about +/-10% around the nominally programmed output current.

The operating frequency of the system and duty cycle can be tuned through careful component value selection as described in the next section.

The output current can be modulated from 0.1X nominal to 2X nominal by actively driving the DIM pin to a DC potential between 0.4V and 2.5V. This DIM pin can also be driven with a low frequency PWM waveform from 0.3V to 1.25V.

The actual startup behavior on initial power up is governed by the presence of an integrated softstart circuit that helps to minimize the effects of in-rush current by causing a gradual increase in the internally generated bias voltage thus causing a very slow rise in the output current. This circuit uses

January 23, 2013

Page 6 of 17

a digital counter triggered by the switching output, and completes its count in 2048 cycles of the LX pin. This internal softstart operates only once at power up, and is then disabled. This function can be disabled externally by driving the DIM pin above 3.0V during power up.

The softstart circuit can be supplemented to provide an even slower softstart ramp with the use of an external capacitor. Softstart is increased at a rate of 0.2mS/F.

A thermal shutdown feature is included that senses the internal junction temperature. If the device temperature increases above 155 °C (typ) the device will turn off until the junction temperature falls below 135C again, when the part begins to operate again.

An under voltage lockout is also included to ensure the device shuts down if input voltage is below 6V. By design, the circuit is also protected against short-circuit and open-circuit conditions.

APPLICATION NOTES:

Setting the nominal average output current with resistor R_s

The value of the external current sense resistor connected between V_{in} and I_{sense} determines the nominal average output current I_{out} in the LED's.

For V_{dim} floating,

I_{out} (steady state) is governed by the equation

$$I_{out} = 0.1/R_s$$

where

$$R_s \geq 83.3m\Omega$$

V_{DIM} float.

Output Current Adjustment by External Control Voltage

The DIM pin can be driven by an external dc voltage as shown to adjust the output current above or below the nominal average value set by R_s .

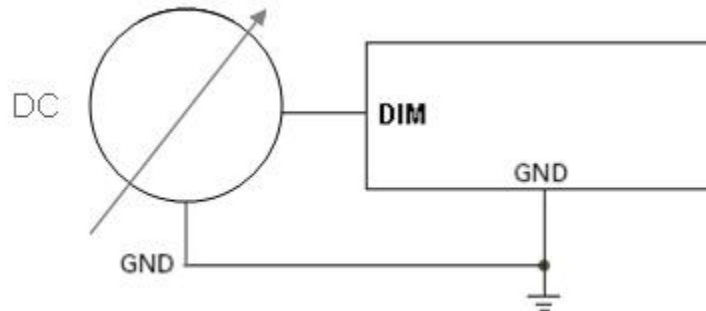

The average output current in this case is given by

$$I_{out} = (V_{dim}/1.25) * 0.1/R_s$$

where

$$R_s \text{ such that } I_{out} \leq 550\text{mA}$$

$$0.3\text{V} \leq V_{DIM} \leq 2.5\text{V}.$$

Note that the maximum supported output current is 550mA for this part R_s must be selected to prevent I_{out} from exceeding this value.

Output Current Adjustment by PWM Control

Directly driving DIM input

A Pulse Width Modulated (PWM) signal with duty cycle DPWM can be applied to the DIM pin, as shown below, to adjust the output current to a value above or below the nominal average value set by resistor R_S :

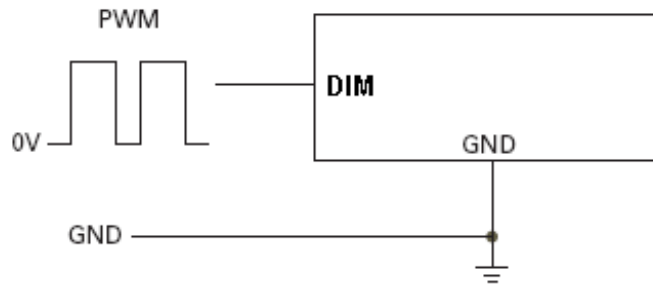

Driving the DIM input via open collector transistor

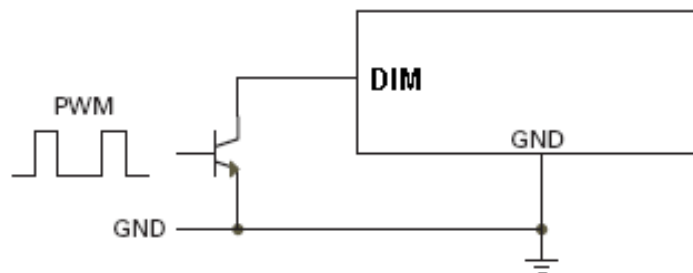

This scheme uses the 40k resistor between the DIM pin and the internal voltage reference as a pull-up resistor for the external transistor e.g. MMBT3904. Note that DIM represents 40Kohm impedance to V_{ref} (nominally 1.25V).

Shutdown mode

Taking the DIM pin to a voltage below 0.2v for more than 100uS will turn off the output and supply current will fall to the low standby current level.

The DIM pin is not a logic pin. Driving it to a voltage between 0.3V and 2.5V will modulate the output current as described above.

Soft-Start

The TXLE10 family of product includes softstart circuitry requiring no external components and is implemented to limit in-rush current. Softstart is implemented with a counter circuit which is incremented by the output switching so the softstart time is a function of the frequency of the

application circuit. The softstart completes in 2048 output cycles. Efficient designs with moderately high switching frequencies will see a softstart time in the 1 to 10mS range.

This integrated soft-start can be further adjusted for specific applications with the use of an external capacitor. The external capacitor connected from the DIM pin to ground will provide a delay by increasing the time for the voltage to rise to the turn-on threshold and slowing down the rate of rise of the control voltage. Adding capacitance increases the delay.

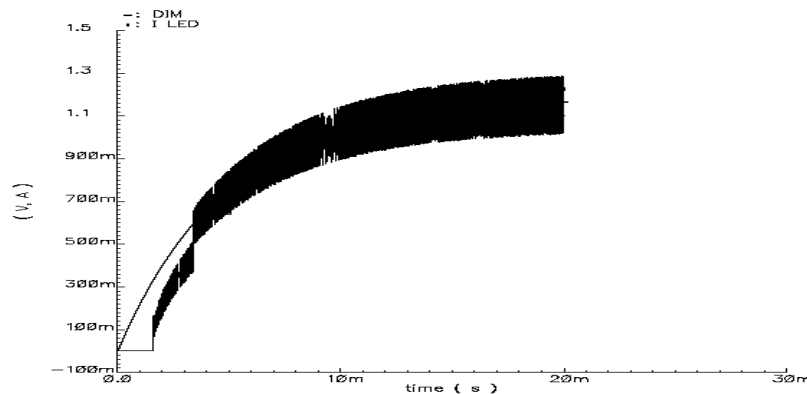

VIN Capacitor Selection

A Low ESR capacitor should be used for input decoupling. The capacitor is required to supply the peak current to the inductance coil L1 and thus smoothing the current ripple on the input supply.

To avoid input transients to the TXLE10 the magnitude of the input capacitor should be selected based on the V_{IN} voltage.

$V_{IN} = 6 \text{ to } 40 \text{ V}$	$C_{IN} = 2.2 \text{ uF}$
$V_{IN} = 40 \text{ to } 50 \text{ V}$	$C_{IN} = 4.7 \text{ uF}$
$V_{IN} = 50 \text{ to } 30 \text{ V}$	$C_{IN} = 10 \text{ uF}$

Capacitors with X7R, X5R or better dielectric are recommended. Capacitors with Y5V dielectric are not suitable for decoupling in this application and should not be used.

Inductor Selection

Recommended inductor values for the TXLE10 are in the range 68 μ H to 220 μ H. Larger inductor values may be used but the user should characterize the circuit to ensure that unwanted behaviors are not observed.

Higher values of inductance are recommended at higher supply voltages in order to minimize errors due to switching delays, which result in increased ripple and lower efficiency. Higher values of inductance also result in a smaller change in output current over the supply voltage range.

The inductor should be mounted as close to the device as possible with low resistance connections to the LX and VIN pins. The chosen coil should have a saturation current higher than the peak output current and a continuous current rating above the required mean output current as calculated in the following equation:

$$I_{L_{max}} = I_{out_{max}} + \frac{\Delta I_L}{2}$$

The inductor value should be chosen to maintain operating duty cycle and switch 'on'/'off' times within the specified limits over the supply voltage and load current range.

The following equations can be used as a guide to compute timing parameters of your design.

LX Switch 'On' time	LX Switch 'Off' time
$T_{ON} = \frac{L \cdot \Delta I_L}{V_{IN} - V_{LED} - I_{AVG} \cdot (R_S + r \cdot L + R_{LX})}$	$T_{OFF} = \frac{L \cdot \Delta I_L}{V_{LED} + VD + I_{AVG} \cdot (R_S + r \cdot L)}$

Note: $T_{OFFmin} > 200ns$

- with:
- L = Inductor Value
 - ΔI_L = Peak to Peak inductor ripple current
 - I_{Lmax} = Maximum Inductor current
 - rL = Coil Resistance
 - I_{AVG} = Required LED current
 - V_{IN} = Supply voltage
 - V_{LED} = Total LED forward voltage
 - R_{LX} = Switch resistance
 - VD = Diode forward voltage at the required load current

Diode Selection

To maximize the efficiency and performance a rectifier diode should be fast low capacitance Schottky diode with low reverse leakage at the maximum operating voltage and temperature.

A suitable Schottky diode would be the 30BQ100PBF (IR)

LED Open-Circuit Protection

When the load (LED string) connected to the TXLE10 is detected to be in an open-circuit condition the output current of the LX pin will be turned off.

LED Short-Circuit Protection

When the load (LED string) connected to the TXLE10 is detected to be in a Short-circuit condition the output current of the LX pin will be limited to its preset value.

Under Voltage Lock Out Protection

When the voltage at the VIN pin is below 4.25v the output switch of the LX pin will be turned off. When VIN again reaches 4.5v the output switch on the LX pin will be turned on again.

Thermal Protection

When the junction temperature of the TXLE10 part exceeds the 155C (typ) threshold the Thermal Protection function turns off the output current and the junction temperature begins to decrease. When the junction temperature drops below 135C (type) the device will be begin to operate again.

With an appropriately designed system with good thermal characteristics, the switching time of the thermal shutdown and restart should be fast and not noticeable to the human eye.

If blinking is observed due to this thermal shutdown circuit the thermal design of the system should be revisited. Improvements in the thermal conditions of the design can be affected by improvements in efficiency through component selection and board layout (larger L, lower Vf for Schottky, shorter traces in series with Rsense, wider traces on LX and GND), thermal mass on the PC board (more copper area, thicker copper), cooling (air flow) or lower application ambient temperature. Additional improvements can be achieved through selection of the highest thermal performance packages (those with exposed thermal pads such as SOIC-8EP).

Device characteristics

Line Regulation

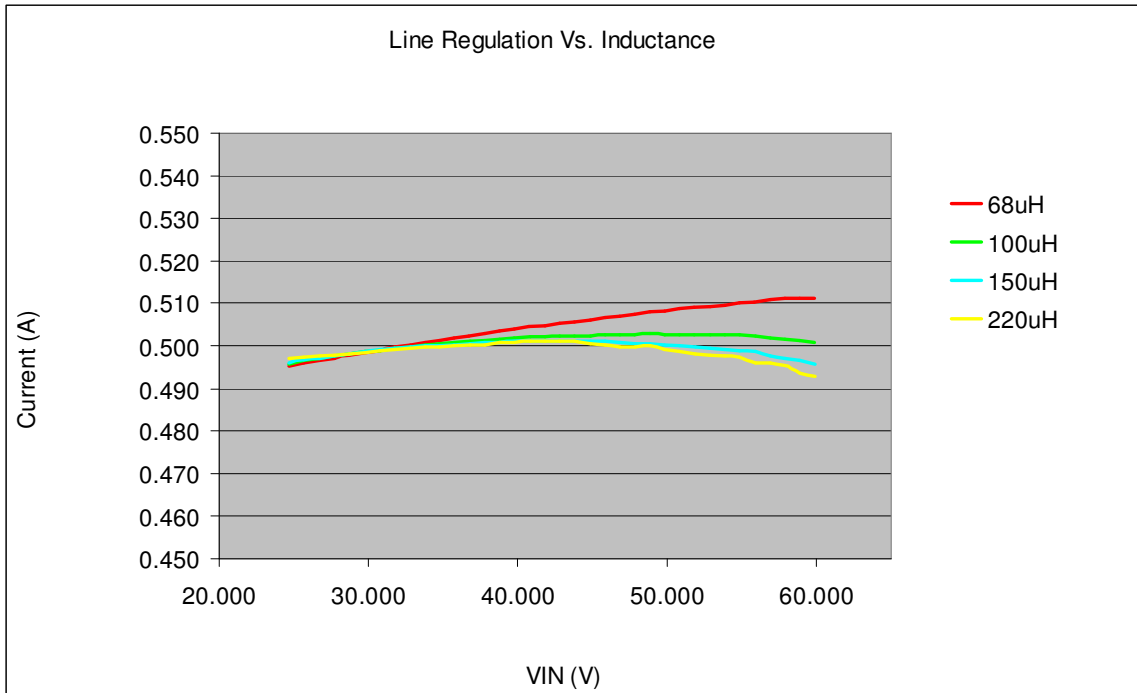

Switching Frequency

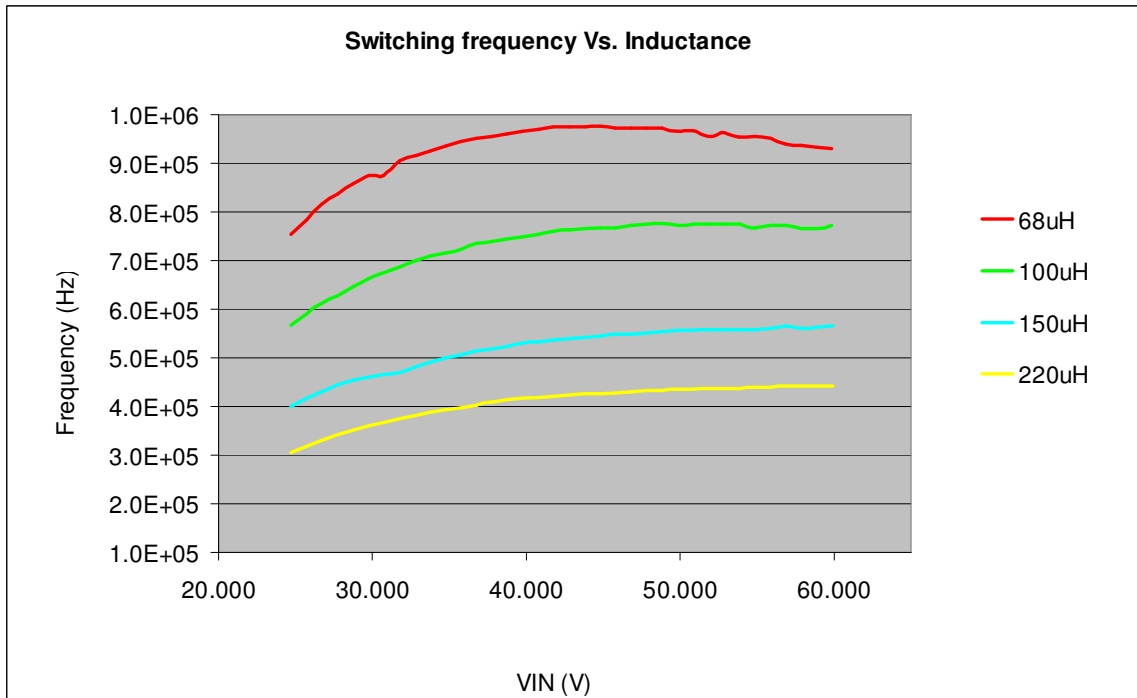

Efficiency

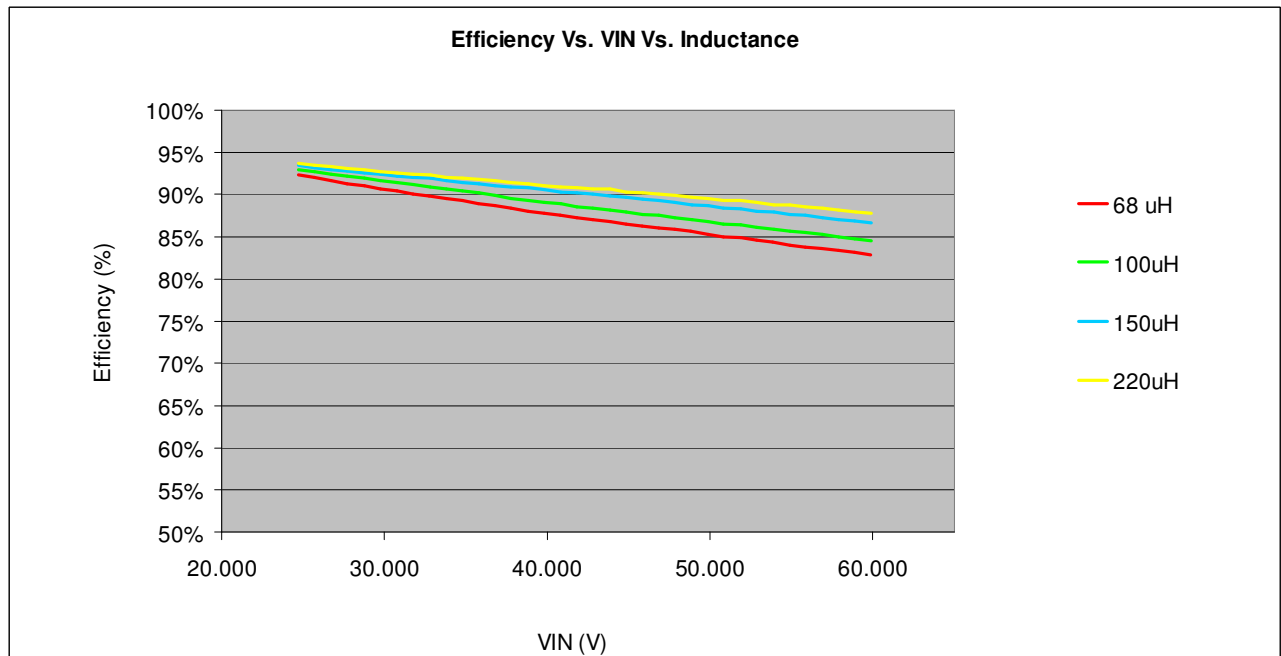
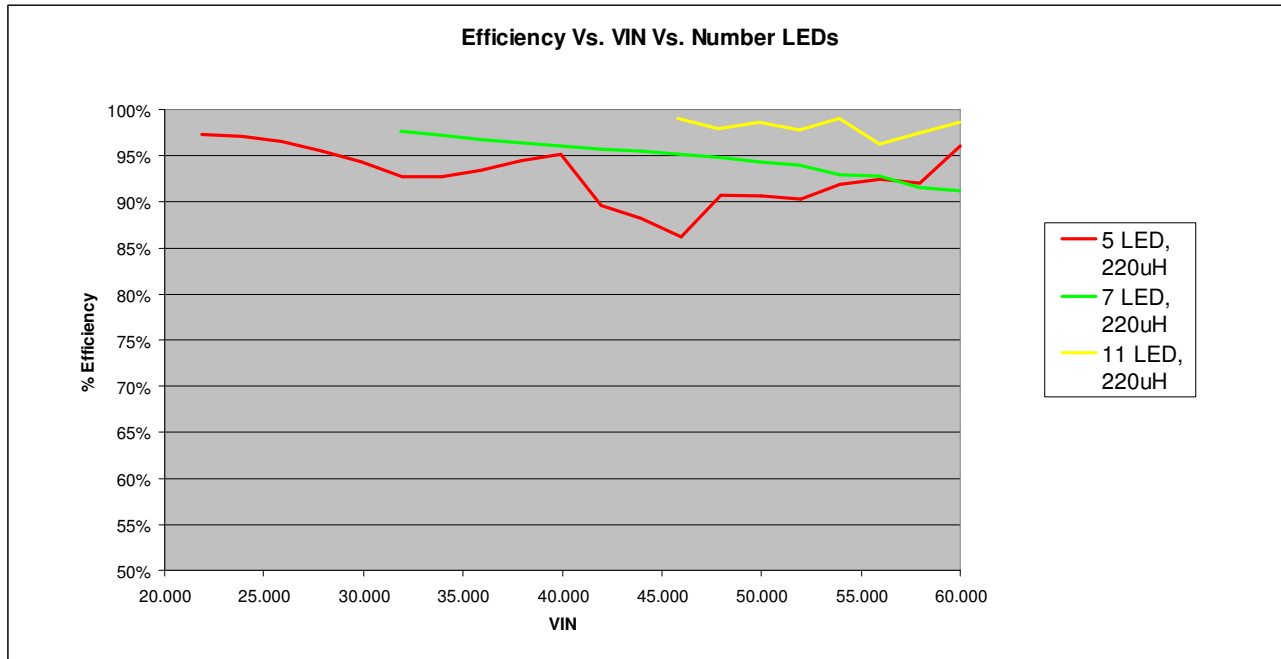

PACKAGE PHYSICAL DIMENSIONS

TSOT23-5L

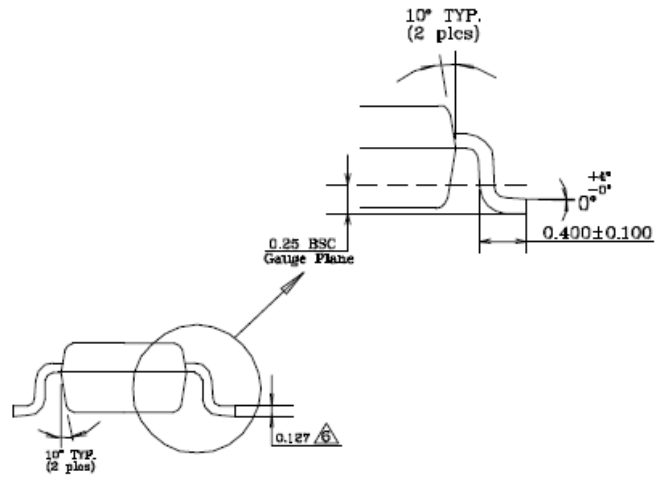
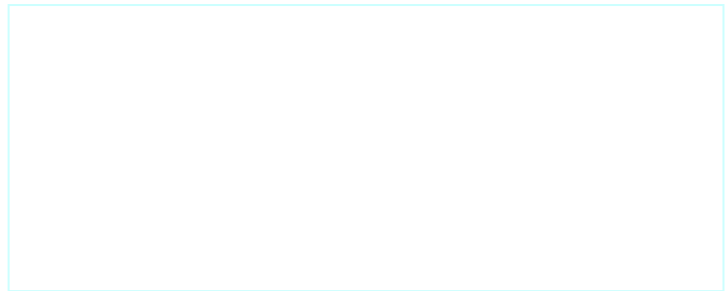
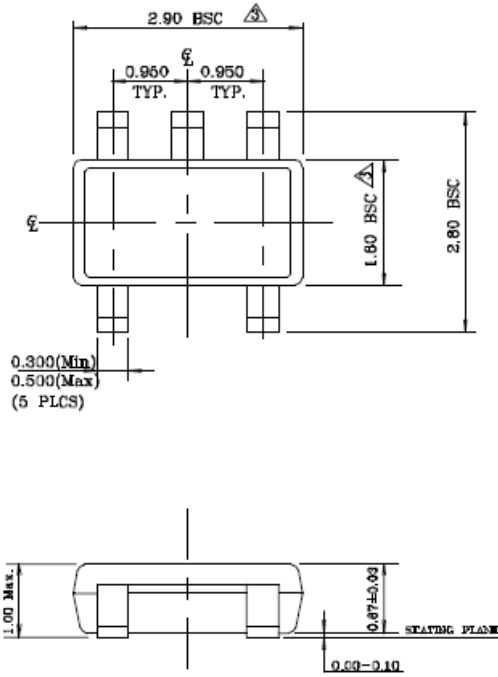

PACKAGE PHYSICAL DIMENSIONS

SOICEP-8L

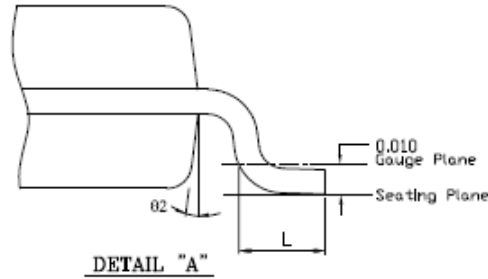
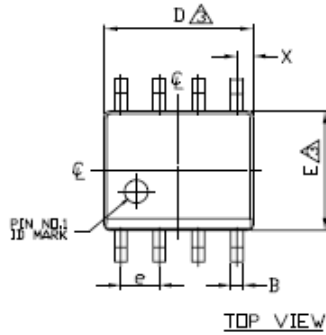

8 SOIC		
SYMBOL	MIN	MAX
A	0.054	0.068
A1	0.001	0.004
B	0.014	0.019
D	0.189	0.196
E	0.150	0.157
H	0.229	0.244
e	0.050 BSC	
C	0.0075	0.0098
L	0.020	0.040
X	0.0215 REF	
01	0°	8°
02	7°	BSC

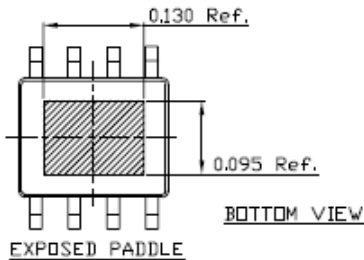
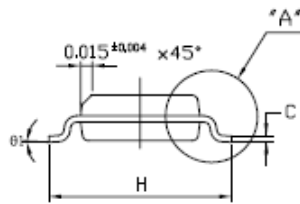
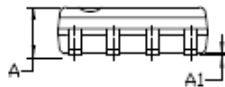

Important Information, Declarations and Disclaimers:

TexChip Technologies Incorporated products are sold by datasheet descriptions. TexChip Technologies reserves the right to make circuit, software or other updates, changes, modifications, adjustments, corrections, improvements, and enhancements to its products and services at any time and to discontinue any product or service without notice. The information provided in this document represents TexChip Technologies awareness and understanding at the time of publication. Customers are cautioned to verify and obtain the most current relevant information before placing orders and should confirm such information is current and complete. TexChip Technologies also bases its knowledge and belief on information provided by third parties, and makes no representation or warranty as to the accuracy of such information. TexChip Technologies continuously pursues reasonable endeavors to provide representative and accurate information but may not have physical or chemical analysis on incoming materials and chemicals. TexChip Technologies and TexChip Technologies suppliers considers certain manufacturing and materials information to be proprietary, and thus Chemical Abstract Services (CAS) numbers (www.cas.org) and other limited information may not be available for release. In no event shall TexChip Technologies liability arising out of such information exceed the total purchase price of the TexChip Technologies product(s) at issue.

All products are sold subject to TexChip Technologies terms and conditions of sale supplied at the time of order acknowledgment. TexChip Technologies supplies a standard warranty of its products to the specifications published at the time of sale. Verification, characterization, inspection and other quality control techniques are used to support this warranty, however, testing of all parameters of each product is not necessarily performed. Customers are responsible for their products and applications using TexChip Technologies products. No responsibility is assumed by TexChip Technologies for its use nor for any liabilities of rights of other third parties resulting from its use. Reproduction of TexChip Technologies information in TexChip Technologies, websites, data books or data sheets is permissible only if reproduction is without alteration and is accompanied by all associated warranties, conditions, limitations, and notices.

TexChip Technologies products are not authorized for use in safety-critical applications (such as life support) or military/aerospace applications or environments where a failure of the Texchip Technologies product would reasonably be expected to cause severe personal injury or death, unless officers of the parties have executed an agreement specifically governing such use.